

CK 12" C UL

Description

The CK is an in-line centrifugal duct fan with high capacity and excellent reliability. The straight through radial fan is compact and very easy to install. It can cope with high pressure and long duct runs, whilst still operating at acceptable sound levels.

The CK range of fans have casings manufactured from galvanized steel and are moisture resistant. They are approved for installation in humid or damp environments being rated IP44 when installed in a duct system.

The fan speed can be controlled by voltage variation regulators. Several fans can be connected to the same controller providing the total rating of the controller is not exceeded.

The motors are an external rotor type asynchrony motor. They have maintenance free sealed ball bearings and are protected from over heating by thermo contacts.

The fans must not be used for transporting grinding dust, soot or similar.

UL file-number: E226987

Technical data

Parameter	value	Unit
Voltage	120	V
Phase	1	~
Frequency	60	Hz
Power	322	W
Current	2,64	A
R.p.m.	2715	r.p.m.
Max. temperature of transported air	70	°C
Max. temperature of transported air when speed-controlled	70	°C
Sound pressure level at 3 m	53	dB(A)
Length	255	mm
Width	402	mm
Height	402	mm
Weight	6,5	kg
Enclosure class, motor	44	IP
Insulation class, motor	F	
Capacitor	30	µF
Duct connection	12 "	



Diagrams

○ Selected point

Flow [l/s]	226
Stat. pres. [Pa]	401
● Work point	
Flow [l/s]	226
Stat. pres. [Pa]	401
Power [W]	322
Current [A]	2,62
Speed [r.p.m.]	2727
Efficiency [%]	28,1
SFP [kW/m ³ /s]	1,4
Voltage [V]	120

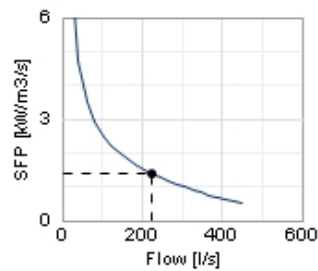
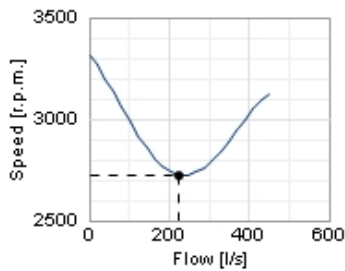
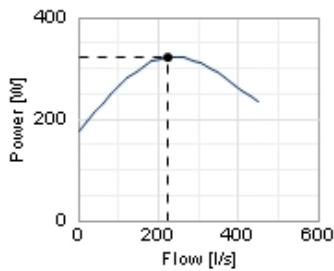
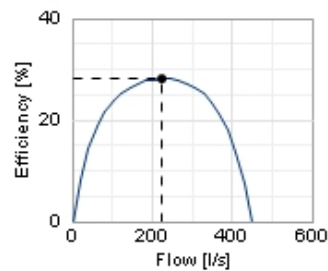
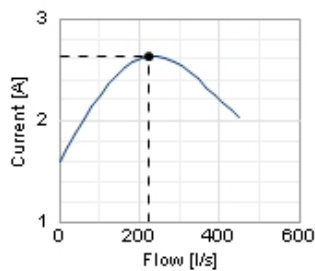
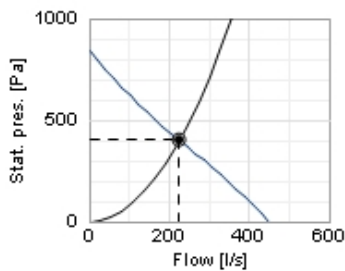

Sound

○ Selected point

Flow [l/s]	226
Stat. pres. [Pa]	401
● Work point	
Flow [l/s]	226
Stat. pres. [Pa]	401
Total press. [Pa]	406
Power [W]	322
Current [A]	2,62
Speed [r.p.m.]	2727
Efficiency [%]	28,1
SFP [kW/m ³ /s]	1,4
Voltage [V]	120

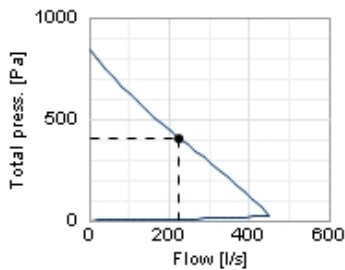
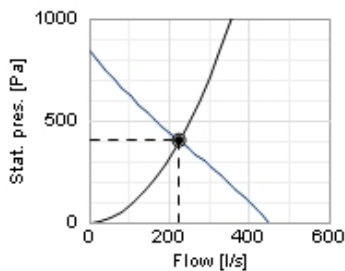

Distance: 3

Propagation type: Semi-spherical

Equivalent absorption area: 20

	Tot	63	125	250	500	1k	2k	4k	8k
Inlet Lw dB(A)	77	54	59	65	69	69	73	69	66
Outlet Lw dB(A)	77	55	61	66	68	72	72	70	65
Surrounding Lw dB(A)	60	38	33	40	50	55	55	51	46
Surrounding Lp dB(A)	53	32	27	33	43	48	48	45	39

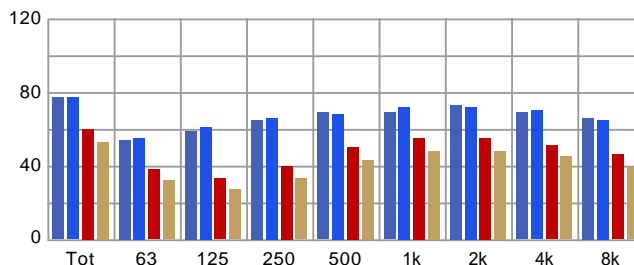

Dimensions

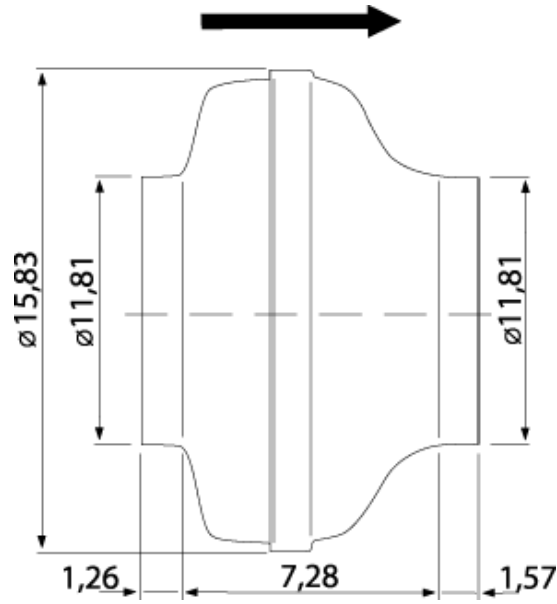

Wiring diagram

4040076

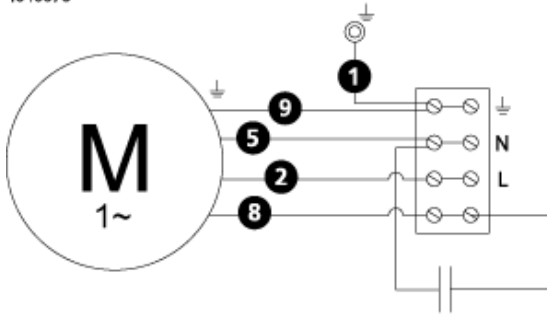

- (M) = Fan Motor
- (M1) = Fan Motor
- (M2) = Fan Motor
- (M3) = Rotor Motor
- 1 = Yellow/Green
- 2 = Black
- 3 = Blue
- 4 = Brown
- 5 = White (TW)
- 6 = Orange
- 7 = Grey
- 8 = Red
- 9 = Green
- 10 = Violet

Accessories